

Rechenpuzzle Weihnachten 1

$16+2=$ ___

$13+3=$ ___

$12+3=$ ___

$15+4=$ ___

$10+2=$ ___

$13+4=$ ___

$11+2=$ ___

$12+2=$ ___

$15+5=$ ___

www.materialwerkstatt.blogspot.de

Illustrationen: www.clipartszgo.de
Schrift: Grunschdrü basic

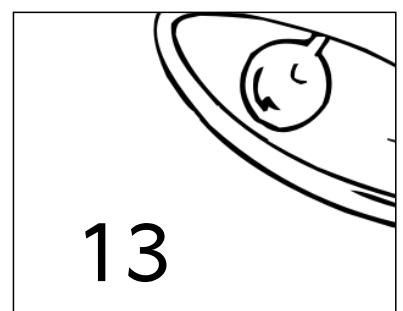
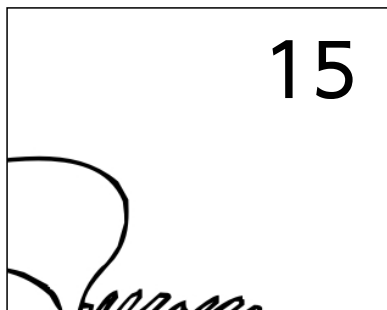

Rechenpuzzle Weihnachten 2

$16-4=$ ___

$17-3=$ ___

$18-3=$ ___

$20-1=$ ___

$19-2=$ ___

$16-5=$ ___

$15-2=$ ___

$20-4=$ ___

$19-1=$ ___

www.materialwerkstatt.blogspot.de

Illustrationen: www.clipartszgo.de Schrift: Grundschrift basic

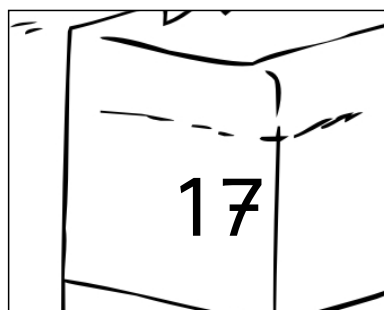
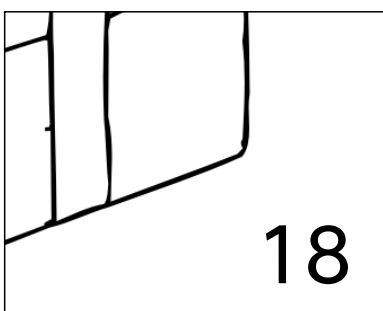
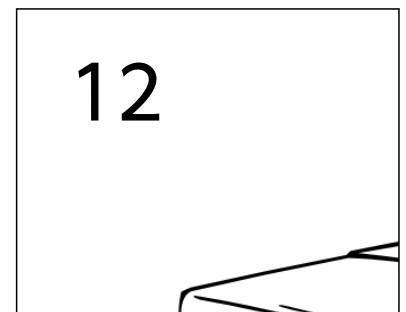
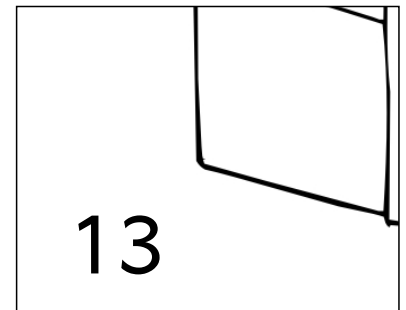
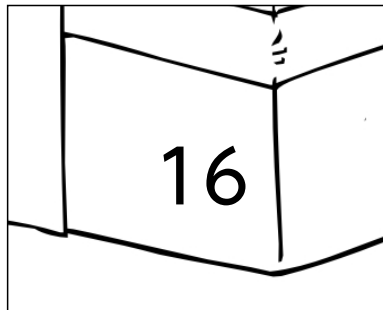
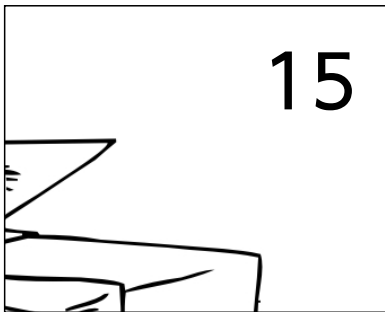

Rechenpuzzle Weihnachten 3

$18-3=$ ___

$14+3=$ ___

$12+7=$ ___

$15-3=$ ___

$18-7=$ ___

$17-4=$ ___

$12+8=$ ___

$11+5=$ ___

$18-4=$ ___

19



12



14



15



16

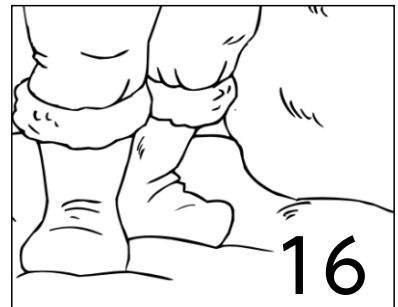

13



20

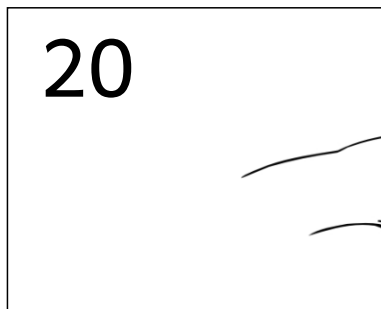

17



Rechenpuzzle Weihnachten 4

$7+8= \underline{\quad}$

$9+4= \underline{\quad}$

$9+9= \underline{\quad}$

$6+5= \underline{\quad}$

$8+8= \underline{\quad}$

$5+9= \underline{\quad}$

$9+8= \underline{\quad}$

$7+5= \underline{\quad}$

$10+9= \underline{\quad}$

www.materialwerkstatt.blogspot.de

Illustrationen: www.clipartszgo.de Schrift: Grunschulru basic



Rechenpuzzle Weihnachten 5

$16-9= \underline{\quad}$

$12-8= \underline{\quad}$

$15-9= \underline{\quad}$

$11-6= \underline{\quad}$

$14-5= \underline{\quad}$

$11-9= \underline{\quad}$

$13-5= \underline{\quad}$

$12-9= \underline{\quad}$

$17-7= \underline{\quad}$

www.materialwerkstatt.blogspot.de

Illustrationen: www.clipartszgo.de
Schrift: Gruschudru basic

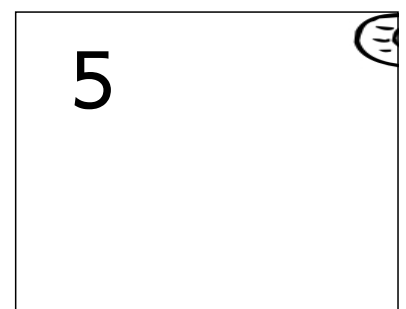
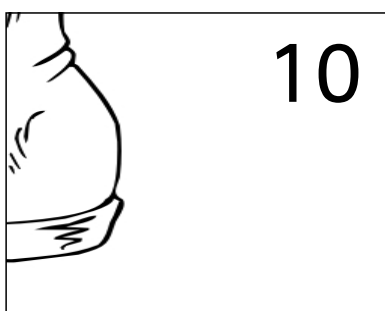
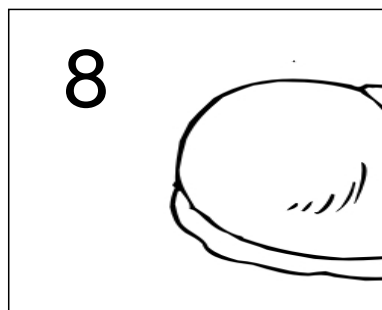
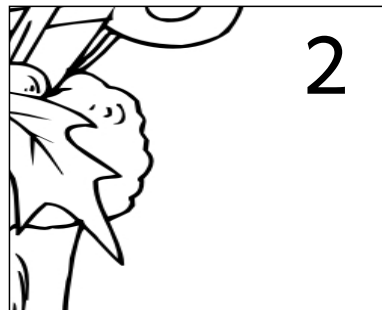
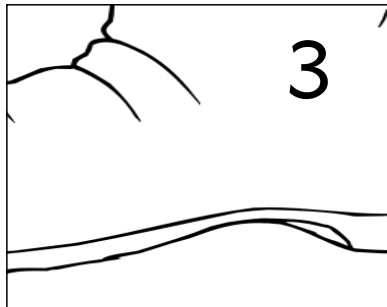

Rechenpuzzle Weihnachten 6

$12 - 7 = \underline{\quad}$

$16 - 9 = \underline{\quad}$

$6 + 8 = \underline{\quad}$

$7 + 6 = \underline{\quad}$

$11 - 5 = \underline{\quad}$

$8 + 4 = \underline{\quad}$

$9 + 7 = \underline{\quad}$

$13 - 5 = \underline{\quad}$

$6 + 9 = \underline{\quad}$

